

Installation and Operating Instructions



Water treatment system for pH, chlorine and ORP



Technical Data

WATERFRIEND *exclusiv*

Nominal voltage	1/N/PE 230V/50Hz
Metering pump chlorine	0 to 10 l / h
Metering pump pH-	0 to 10 l / h
Metering pump pH+ (option)	0 to 10 l / h
Metering pump flocculation (option)	
Protection class	IP 20
Housing size	625 x 390 x 130
Humidity	0 to 95%, non condensing
Ambient temperature	0 to 40 °C
Measuring water pressure	max. 2 bar
Measuring water flow rate	0,5 l/min.



Made by OST

Subject	Table of contents	Page
General		5
Safety information		5
Installation and operating manual		5
Canister		5
Personnel qualification		5
Installation		6
Mounting		6
Installation in the water circuit		6
Schematic		6
Measurement water pump		7
General informations on installation in the water circuit		7
Electrical connection		7
Low-voltage cables		7
Wiring diagram		7
Alarm		8
External pumps		8
Enabling		8
Connection to EUROMATIK.net		8
Connecting to the computer network		8
Testing the internet connection		9
Using the osf communication server		9
Communication server for pool owners		10
Registering a new device with the server		10
Communication server for pool installers		11
Registering a new device with the server		11
Communication server with technical view		12
Registering a new device with the server		13
Changing the PIN (password)		14
Assigning a new PIN		14
Naming the unit and entering an e-mail address		14
Entering an e-mail address.....		14
Assigning a name		14
Update		15
Checking for updates.....		15
Touchpanel		16
Display		16
Analog display		16
Temperature		17
Measurement water flow quantity		17
Regulation status		17
Initial setup		18
Select language		18
Set date and time		18
Adjust the flow rate of the measurement water		18
Calibrate the sensors.....		18

Turn on automatic dosing.....	18
Förderleistung der Dosierpumpen einstellen	18
Operation.....	19
Child lock.....	19
Professional mode (expert level).....	19
pH regulation	20
Switching pH regulation on or off	20
Setting the pH target value.....	20
Setting the lower pH alarm	20
Setting the upper pH alarm	21
Calibrating the pH electrode.....	21
Calibrating the current working point or upper value (pH 7)	22
Calibration of the lower value (pH 4).....	22
pH calibration errors	22
pH power on delay	23
Setting the maximum pH metering time	23
Setting the pH proportional range	24
Meaning of the proportional range	25
pH metering pump flow rate	25
Chlorine regulation.....	26
Switching chlorine regulation off or on	26
Setting the chlorine target value.....	26
Setting the lower chlorine alarm.....	27
Setting the upper chlorine alarm	27
Calibrating the chlorine sensor.....	27
Chlorine calibration errors	28
Power-on delay of chlorine regulation	28
Setting the maximum chlorine metering time	29
Setting the chlorine proportional range	29
Impact of the proportional range	30
Chlorine metering pump flow rate	31
ORP display	31
Setting the lower ORP alarm.....	31
Setting the upper ORP alarm	32
Setting the ORP power on delay.....	32
Calibrating the ORP electrode	33
ORP calibration errors.....	34
Info and alarm display.....	34
Acknowledgement of alarm messages	34
Graphic of the measured values	34
Operation log	35
Manual operation.....	35
Venting the dosing tubes.....	35
Shock chlorination	35
Flocculation (Option)	35
Setting the capacity of the flocculation pump.....	35
Switching the flocculation off or on.....	36
Venting the flocculation tube	36
Settings for the service technician.....	36

Settings for the real time clock	36
Automatic Internet time.....	36
Time zone	37
Manual time setting	37
Automatic daylight saving time	37
Audible alarm.....	37
Alarm settings.....	38
Restore factory settings.....	38
Settings for network operation.....	38
Using the OSI-communication server.....	38
Automatic IP address configuration (DHCP)	38
Manual IP address configuration	39
PIN-Numbers	39
Language selection	39
Operating hours counter.....	40
Device informations	40
Configuration of the metering pumps	40
Raise pH <=> lower pH	40
Function of the third metering pump (option)	41
Bidirectional control for pH (pH+ and pH-)	41
Calibration of the temperature sensor	41
Alternative operation with ORP control	42
Connecting the MRD-3 to the external touch control panel (smart).....	42
Maintenance	42
6-monthly service.....	42
Sealtightness	42
Dirt filter	42
Injection valves	43
pH electrode	43
ORP electrode	43
Metering pumps.....	43
Annual service.....	43
Replacing ORP and pH electrodes	43
Replacing the metering hose.....	43
Decommissioning	43
Electrodes.....	43
Measuring chamber.....	43
Metering pumps.....	43
Wear parts	43
Interfacing with building automation systems	44
Shipment of the dosing system	47

General

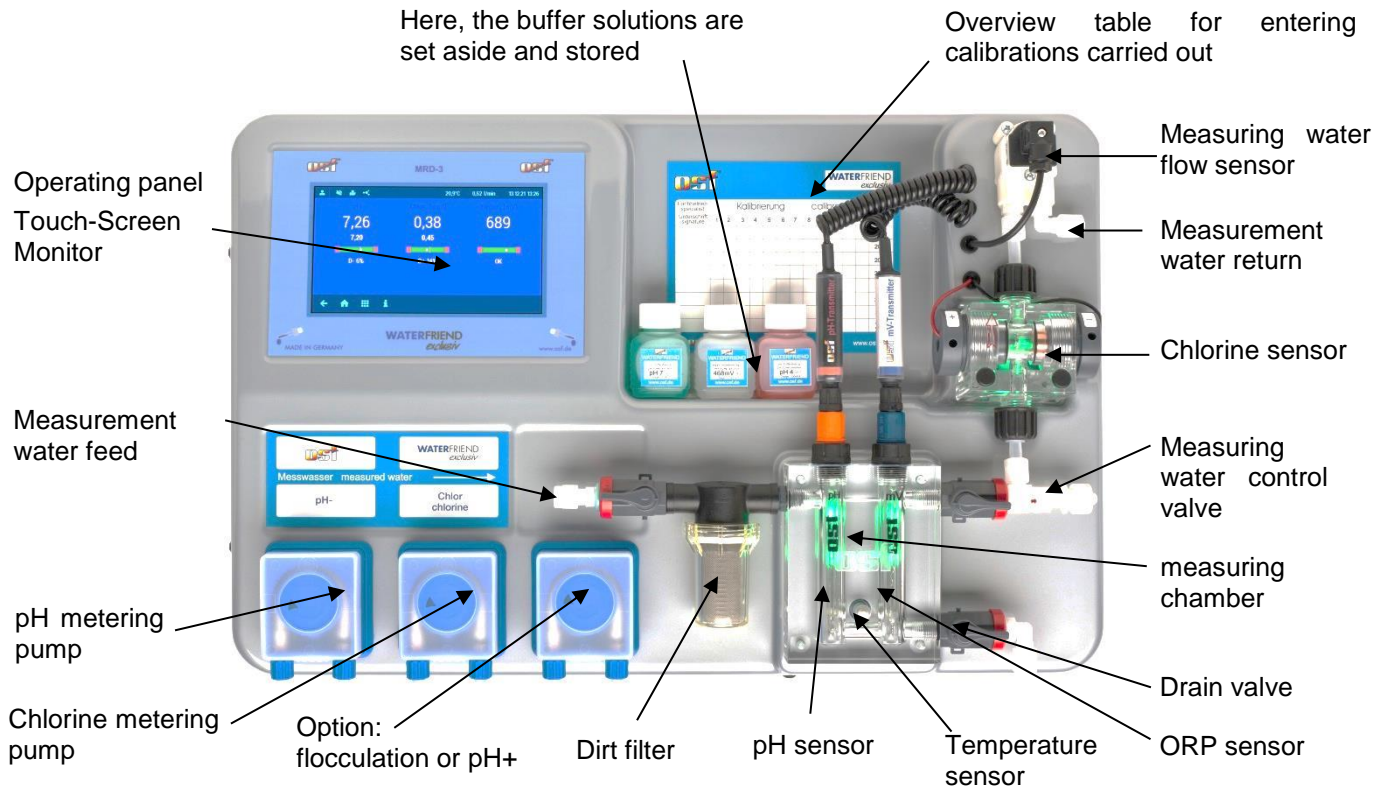

Safety information

Installation and operating manual

This operating manual contains important information which must be observed during installation, operation and maintenance of the metering unit. For this reason, it is imperative that this operating manual is read by the fitter and the responsible specialist personnel or equipment owner before installation and initial start-up. It must be continuously available at the device installation location.

Caution

The metering liquids used are corrosive or highly flammable. The two pressure hose ends at the hose pumps must never be hanging freely, otherwise corrosive or highly flammable liquids can be discharged.

Canister

The canisters containing the metering liquids must be placed in **tsi** interception troughs. They may never be placed directly underneath the controller. Gas-emitting chemicals can cause damage to the sensitive controller.

Personnel qualification

The personnel who will be operating, maintaining, inspecting and installing the device must have appropriate qualifications for this work. The plant operator must precisely define the areas of responsibility, responsibilities and monitoring of the personnel. If the personal does not have the required knowledge, they must be trained and instructed. This can be carried out by the manufacturer or supplier on behalf of the owner if required. Furthermore, the owner must ensure that the contents of this operating manual have been understood by his personnel in all respects.

Installation

You have purchased a high-quality measuring, regulating and metering device with the **osfi** WATERFRIEND. The device is a precise and sensitive system which needs to be handled carefully at all times.

Please handle the protective cover carefully as well. It may not be allowed to fall down or come into contact with chemicals. The protective cover should be cleaned using a soft cloth and a little water if necessary.

All regulations and provisions applicable to the place of installation must be observed during installation.

The swimming pool must be constructed such that a possible technical malfunction, power failure or a defective metering system may not cause any consequential loss.

Mounting

The bottom housing section is fixed vertically and permanently to a solid wall with suitable load-bearing capacity. Please ensure that the measuring cells are vertical after this has been carried out. The installation location must be protected against dust and water in order to guarantee correct and proper functioning of the device. The surrounding temperature must be between -0°C und $+40^{\circ}\text{C}$ and should be kept as constant as possible. Humidity at the installation site may not exceed 95%, and no condensation may take place. Please avoid direct heat or sun irradiation onto the device.

Installation in the water circuit

Please observe all valid safety regulations when carrying out installation work, and ensure that this is carried out carefully. Disconnect the measuring, regulation and metering device and all other electrical consumers such as filter pumps and heaters from the power supply.

Schematic

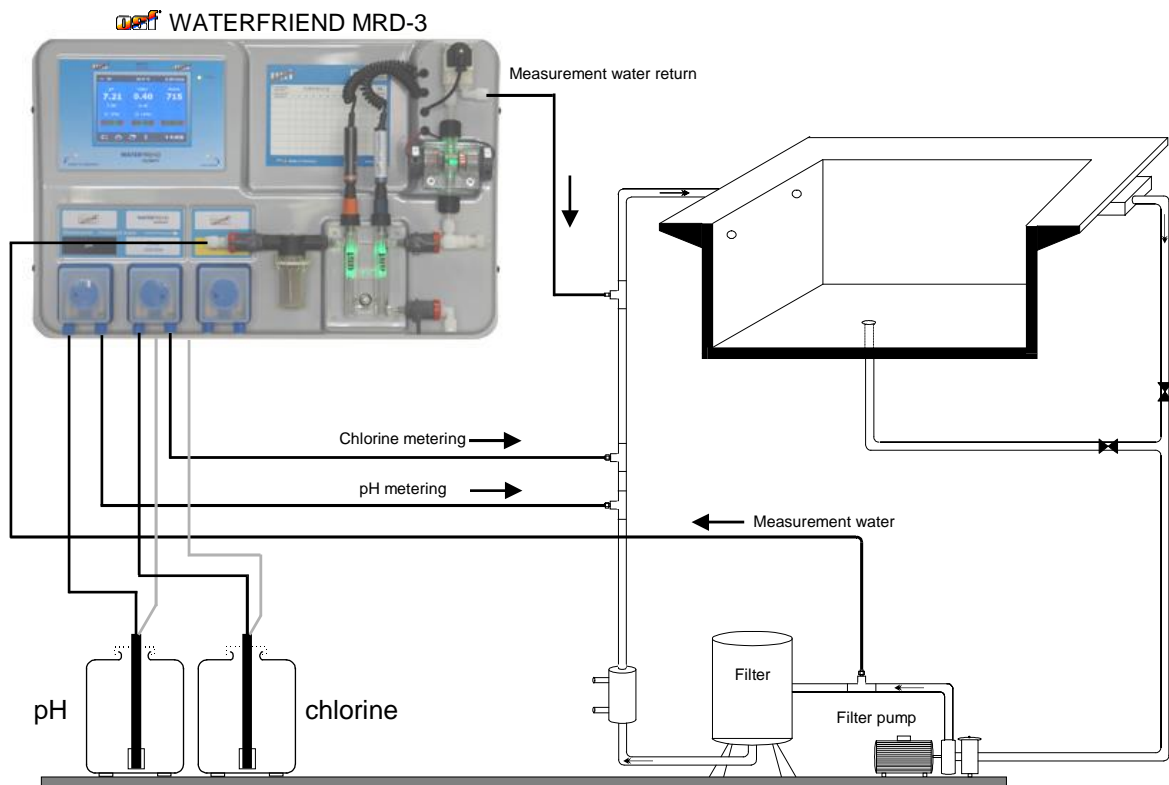

Measurement water pump

The dosing "WATERFRIEND" requires a continuous supply of sample water with a water amount of 0.3 to 0.8 liters per minute (optimal: 0.5 l/min). A higher measuring water flow leads to increased wear of the chlorine sensor. When using filter pumps with variable speed or in unfavorable pressure conditions of the eventual use of a sample water pump must be checked.

General informations on installation in the water circuit

- Before carrying out initial start-up, ensure that the injection valves open and close reliably.
- All hoses must be routed free of kinks.
- Avoid routing hoses over sharp edges.
- Connect all hoses carefully and check to ensure that they are tightly fitted to their connections.
- Avoid unnecessarily long hose lengths.
- Hoses may not be routed directly over pipes carrying heat or over other devices.

Electrical connection

The controller must be mounted protected against moisture in accordance with its protection class. The device must be powered via a multi-pole main switch with a contact opening width of at least 3mm and a residual current circuit breaker with $I_{FN} \leq 30\text{mA}$. **The device must be isolated before opening the housing. Electrical power supply connections, in addition to alignment and service work, may only be carried out by approved electricians. The attached circuit diagrams and all applicable safety regulations must be observed.**

Low-voltage cables

Low-voltage cables may not be routed together with three-phase or alternating current cables in one cable duct. Routing of low-voltage cables in the vicinity of three-phase or alternating current cables should generally be avoided.

Wiring diagram

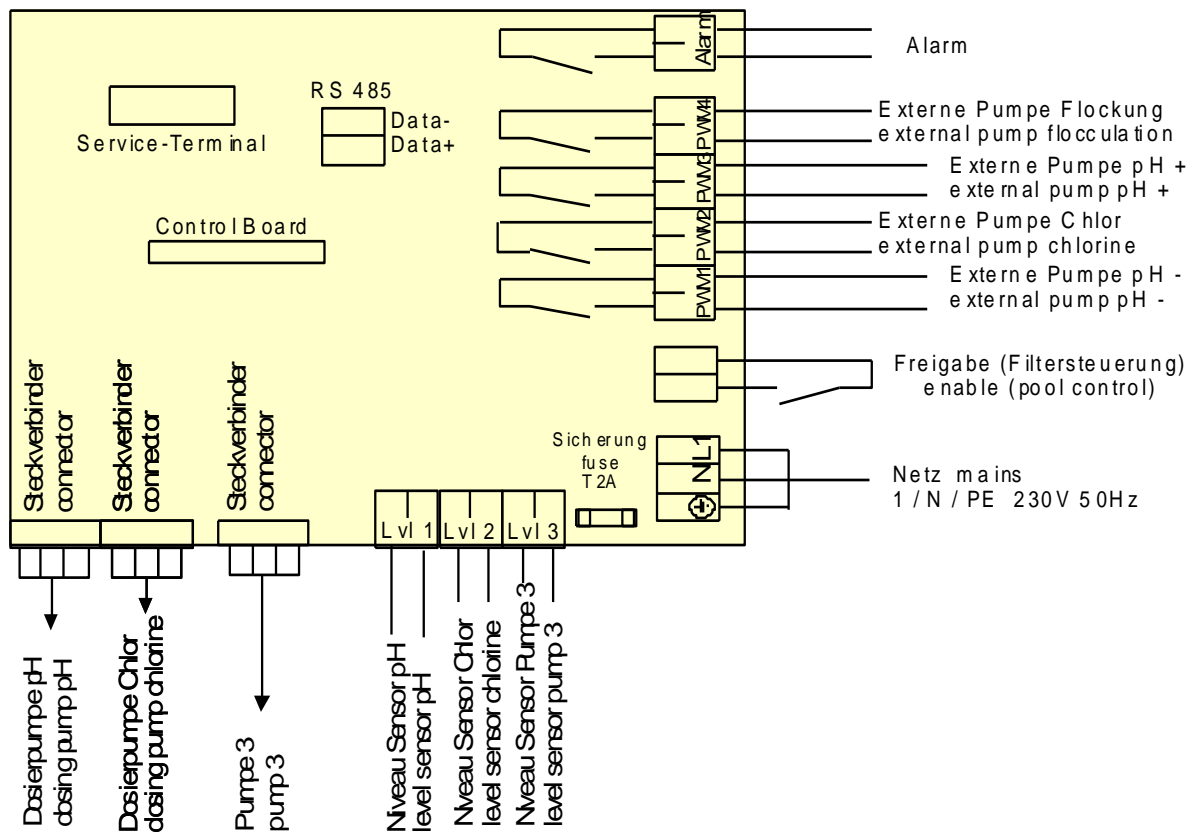

Alarm

An external acoustic or optical alarm can be connected to these terminals. These terminals can also be used for connection to group error messaging systems. The terminals can be loaded with maximum 230V 1A.

External pumps

These connecting terminals are control contacts for external metering pumps. The terminals can be loaded with maximum 230V 1A.

These outputs deliver clock signals with pulse duty factors that are proportional to the current dosing rate of the built-in dosing pumps and thus enable the stepless control of external pumps.

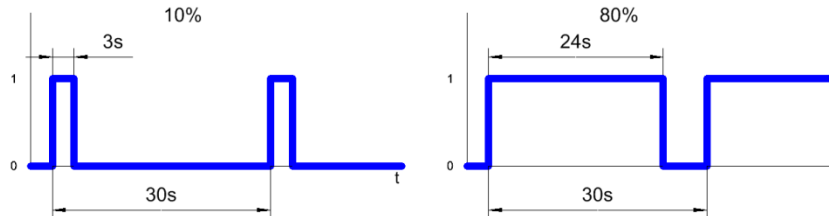

For safety reasons, the outputs for pH and chlorine are locked against each other, i.e. when the pH metering pump is working, the chlorine metering pump is always switched off.

Enabling

At these terminals the dosing enable signal of the filter control system must be connected. The opening of the floating contact within the filter control interrupts the dosing. The filter control must ensure by this signal that dosing will only be enabled when there is sufficient water flow at the injection point.

Connection to EUROMATIK.net

These terminals are used for connection to the nsf Euromatik.net filter control unit. A screened, twisted, 2-core cable (twisted pair) with a cross-section of at least 0.22 mm² is required for the connection. (e.g. Li2YCY(TP) 2 x 0.22 mm²). Screening improves the electromagnetic compatibility (EMC). The cable length of the complete bus-system may not exceed 1200 m. The polarity (DATA+ and DATA-) must be observed.

Connecting to the computer network

Connection to the Internet is carried out by the nsf communication server. The WATERFRIEND MRD-3 is connected using a standard Ethernet patch cable into the network wall outlet, the powerline adapter, the wireless LAN access point or other suitable facilities.

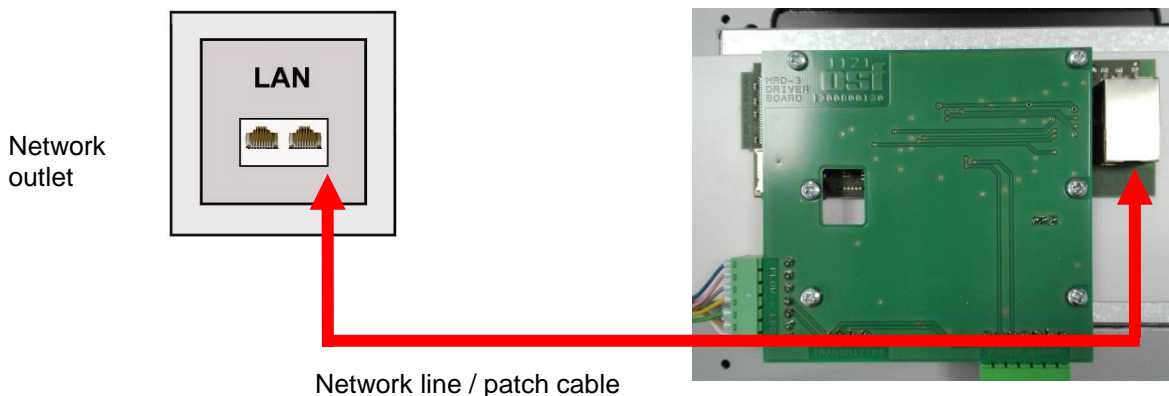

After the WATERFRIEND was connected to an active network outlet, the power supply can be turned on. The web server in WATERFRIEND now searches autonomously for the communication server and logs on to the database.

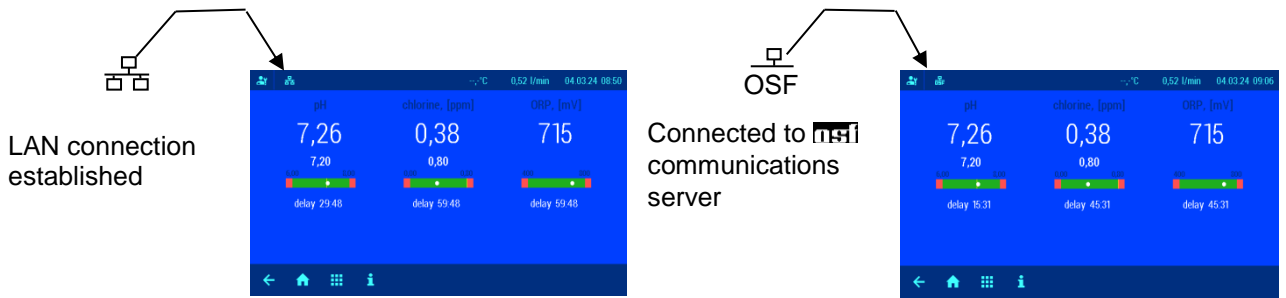

If the "OSF" icon in the monitor is visible (see chart), the WATERFRIEND has logged on to the OSF communication server.

Testing the internet connection

The connection of the device to the Internet and to the osf communication servers can be easily checked by calling the osf Device Finder. You can reach the device finder at the following address:

<https://osfdevice.de/b/finder/index.php>

or by scanning the QR code adjacent:





If you enter the device ID of your device in this input field and then click the magnifying glass button, you will be shown a link and a QR code to connect to your device. If you then follow the link displayed, you will be taken directly to the home page of your device. For convenient access to your device, this home page can also be saved as a web app on mobile phones.

Using the osf communication server

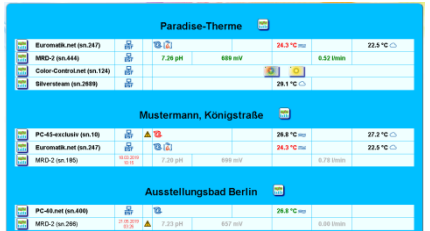
There are four servers available for communication. They each display different information, designed to suit the needs of different user groups.

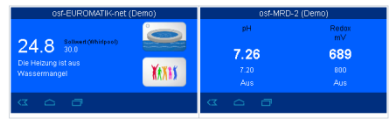
<p>MyPool.osf.de</p>	<p>This server is designed for pool owners. The entire pool system including all web-enabled osf products is displayed on one page on the monitor. The key data for all devices can be retrieved with a single tap of a button.</p>	
<p>Service.osf.de</p>	<p>This server is designed for pool installers. The top-level page shows all registered pool installations in a clear layout on the monitor. All main parameters and any fault indicators for every customer system are visible at a glance.</p>	

<p>Devices2.osf.de</p>	<p>This server provides the usual technical view for all connected osf devices.</p>	
<p>Devices.osf.de</p>	<p>For the time being it is still possible to use this familiar server, which has been available for many years. For new installations, however, we recommend the "mypool.osf.de" and "service.osf.de" servers, and "devices2.osf.de"</p>	

Communication server for pool owners

You can access this osf communication server at the address mypool.osf.de



You must first register as a new user:

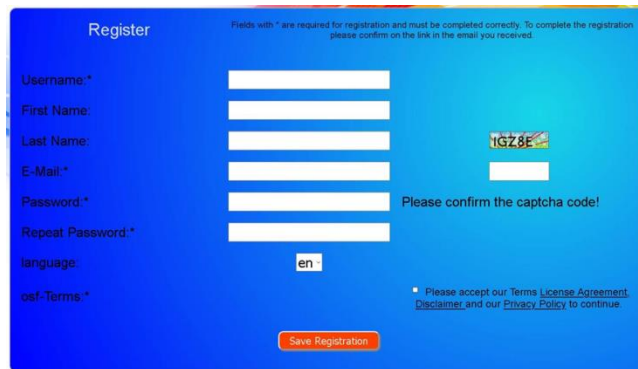

Within a few minutes you should automatically receive an e-mail for confirming your identity. (Check your Spam folder if the e-mail does not arrive). Click the activation link in the e-mail to activate your account.

Registering a new device with the server

Once you have personally registered, you can log in and then register your new device in your user profile. Each web-enabled osf control unit has a DEVICE ID (identification number). This DEVICE ID must be entered in the correct column in order to register the device with the communication server. You can find the DEVICE ID of your device displayed on its Information page (see above). For devices without a display, the ID number appears on an adhesive label. When finished, save the information you have entered.



Nr	Object name	ID #1	ID #2	ID #3	ID #4
1					
2					
3					
4					

If you press the “Your devices” button, your device is now displayed in your Device panel and can be operated via the communication server:

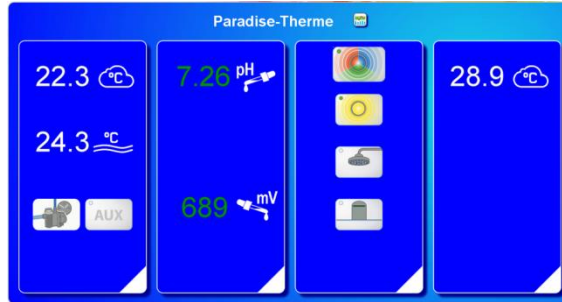

In order to use the communication server, the option "Internet connection via communication server" must be enabled in the control unit itself (default factory setting):

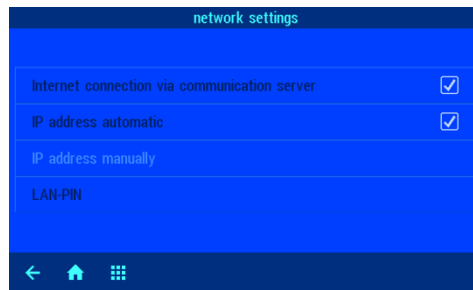

Communication server for pool installers

You can access this osf communication server at the address service.osf.de



You must first register as a new user:

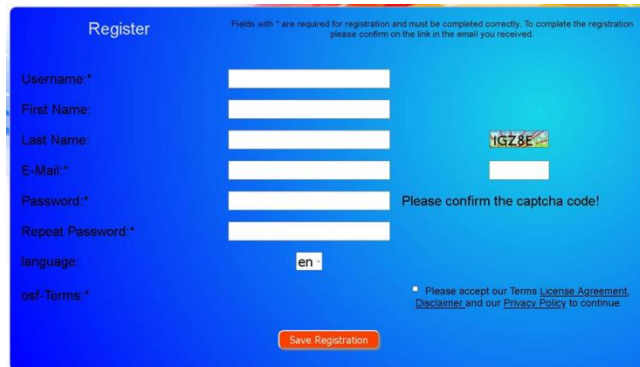

Within a few minutes you should automatically receive an e-mail for confirming your identity. (Check your Spam folder if the e-mail does not arrive). Click the activation link in the e-mail to activate your account.

Registering a new device with the server

Once you have personally registered, you can log in and then register your new device in your user profile. Each web-enabled osf control unit has a DEVICE ID (identification number). This DEVICE ID must be entered in the correct column in order to register the device with the communication server. You can find the DEVICE ID of your device displayed on its Information page (see above). For devices without a display, the ID number appears on an adhesive label. When finished, save the information you have entered.

Complete the form

Enter the DEVICE ID

nr	Object name	ID #1	ID #2	ID #3	ID #4
1					
2					
3					
4					

If you press the "Your devices" button, your pool installations are now displayed in your Device panel. This lists the pool installations for all your customers in a table. You can see all the main information at a glance. Fault indicators are highlighted for each pool individually. To display and operate a specific device via the communication server, simply press the associated button for this device:

Connected to the osf communication server

Server connection lost at ...

Customer name

The Paradise-Therme baths contain 4 web-enabled osf devices

Display graphs

Paradise-Therme						23.2 °C	21.6 °C
Euromatik.net	OSF						
MRD-2	OSF	7.26 pH	689 mV			0.52 l/min	
Color-Control.net	OSF						
Silversteam	OSF				28.1 °C		

Mustermann, Königstraße						27.6 °C	27.7 °C
PC-45-exclusiv	OSF	27.06.2019 10:06					
Euromatik.net	OSF				23.2 °C		21.6 °C
MRD-2	OSF	18.03.2019 10:15	7.20 pH	699 mV		0.78 l/min	

Kundengerät						30.0 °C	
PC-40.net	OSF						
MRD-2	OSF	21.05.2019 03:26	7.23 pH	657 mV		0.00 l/min	

In order to use the communication server, the option "Internet connection via communication server" must be enabled in the control unit itself (default factory setting):

network settings

- Internet connection via communication server
- IP address automatic
- IP address manually
- LAN-PIN

Communication server with technical view

You can access this osf communication server at the address devices2.osf.de

Online-Device-Control

Login

Username: _____

Password: _____

Forgot Password

Login

You must first register as a new user:

Within a few minutes you should automatically receive an e-mail for confirming your identity. (Check your Spam folder if the e-mail does not arrive). Click the activation link in the e-mail to activate your account.

Registering a new device with the server

Once you have personally registered, you can log in and then register your new device in your user profile. Each web-enabled osf control unit has a DEVICE ID (identification number). This DEVICE ID must be entered in the correct column in order to register the device with the communication server. You can find the DEVICE ID of your device displayed on its Information page (see above). For devices without a display, the ID number appears on an adhesive label. When finished, save the information you have entered.

Nr	Object name	ID #1	ID #2	ID #3	ID #4
1					
2					
3					
4					

Your device is now displayed in your Device panel and can be operated via the communications server:

In order to use the communication server, the option "Internet connection via communication server" must be enabled in the control unit itself (default factory setting):

Changing the PIN (password)

The MRD-3 contains 2-level password protection for access via the LAN. The User PIN lets you operate the control unit and adjust the essential main functions. The Service PIN is needed to perform service functions and to change settings at the Service level. The following PINs are factory-set:

- User-PIN: 1234
- Service-PIN: 5678

Assigning a new PIN

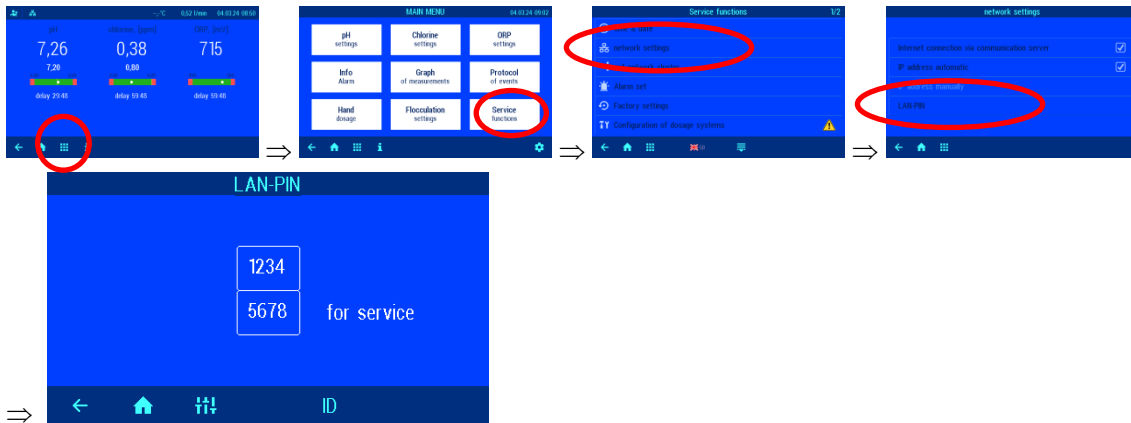

The PINs for users and services can be changed on this page.

Naming the unit and entering an e-mail address

In order to be able to identify different control units during online access, each osf device has a facility for assigning a name.

The MRD-2 is able to send any fault indicator messages via e-mail. The control unit must be connected to the Internet for this feature to work. You enter the relevant e-mail addresses (2 maximum) via the WEB interface of the communication server.

Entering an e-mail address

Assigning a name

1. Log in as usual to the communication server
2. Then log in on the device with the Service PIN
3. In the Home page, press the “menu” button
4. In the main menu, press the „Service“ button
5. In the service menu, press the “Network Settings” button

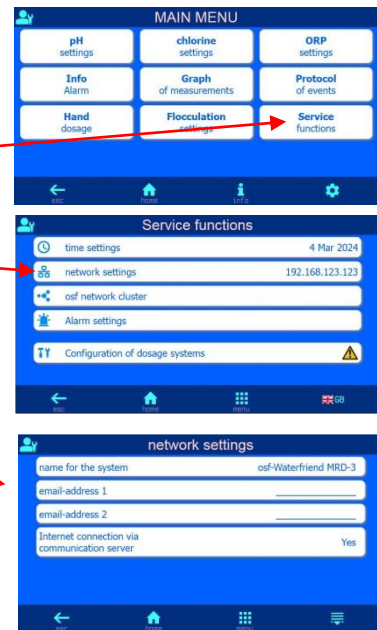

Here you can enter the name of the system and the email addresses

Update

The MRD-2 has a software update facility. The MRD-2 must be connected to the Internet for updating to work. You can perform the update via the WEB interface of the communication server.

Checking for updates

You can use this function to check whether an update is available for your device.

1. Log in as usual to the communication server
2. Then log in on the device with the Service PIN
3. On the homepage, press the “esc” button



4. On the Info page, press the “Check for Update” button

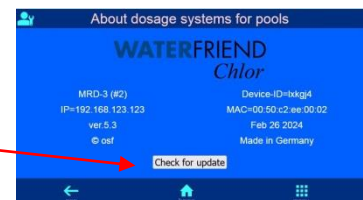

5. You can now start the download and install the update



Touchpanel

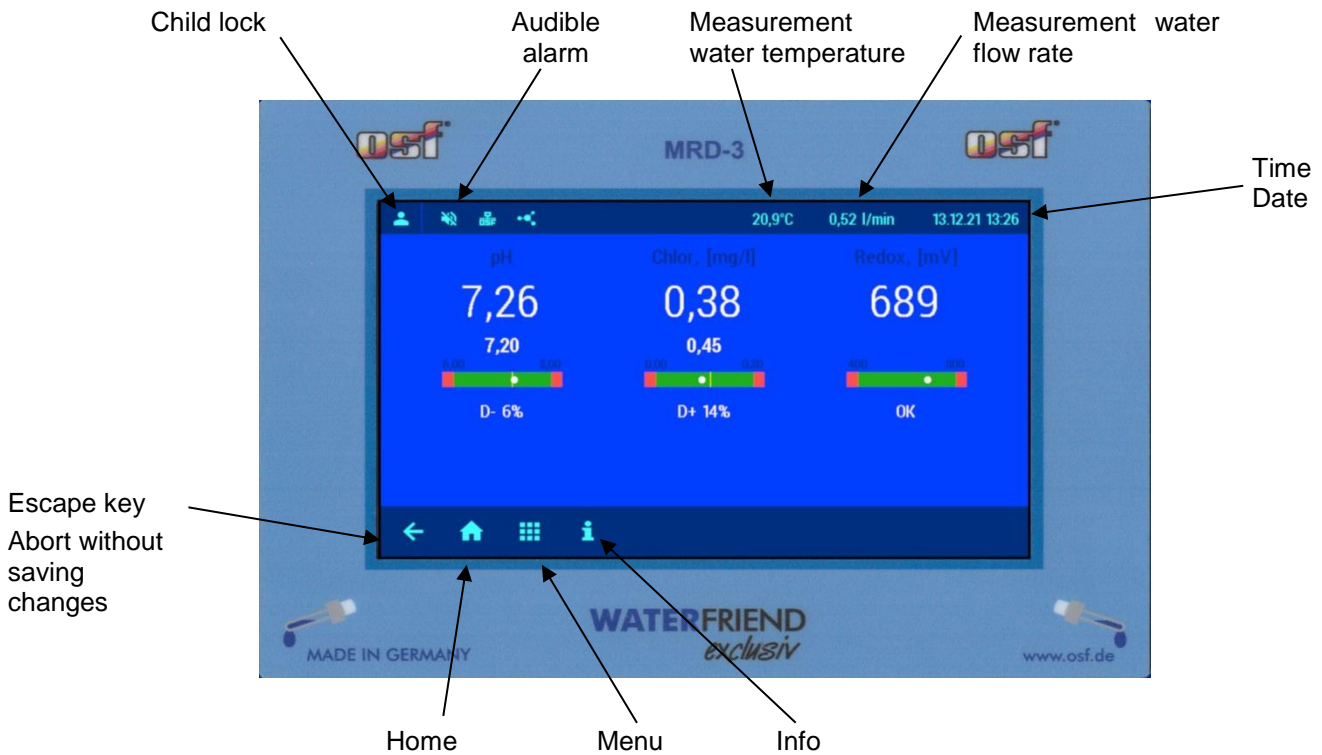

Display



Analog display

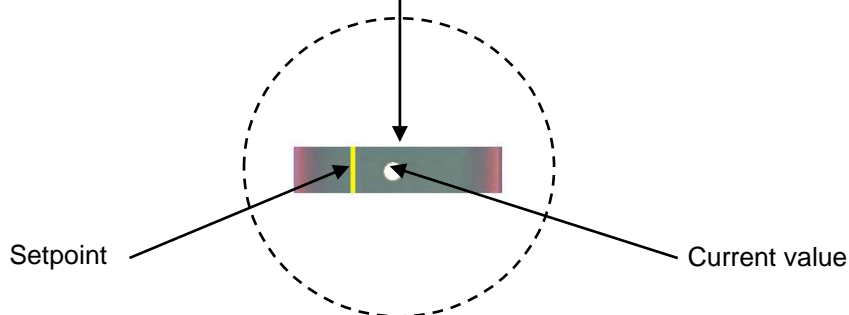

Temperature

The displayed temperature is the measurement water temperature within the flow fittings. This can deviate from the actual water temperature in the swimming pool depending on the pipeline routing and surrounding temperatures.

Measurement water flow quantity

quantity of water flowing through the measuring chamber. The chlorine regulation only works with a flow rate in the range between 0,3 and 1,0 l/min.

Regulation status

In the "Regulation status" fields, additional information about the respective operating status of the individual controllers is displayed:

Display	Meaning
OFF	The controller is out of order
D ± xx %	Display of the current dosing rate and the dosing direction
too high	The measured value has exceeded the specified upper alarm limit value.
too low	The measured value has exceeded the specified lower alarm limit value.
pause	The control was temporarily interrupted by the operator.
flow	The control was temporarily interrupted because the sample water flow rate is outside the permissible limits and therefore no reliable measurement is possible.
ext. lock	The regulation was blocked by the enable signal of the filter control.
delay	The control is not yet active because the switch-on delay for stabilizing the measured values has not yet ended
tank	The chemicals canister is empty.
pH too high	The chlorine dosing is temporarily blocked because the pH value is too high for reliable chlorine control.
pH too low	The chlorine dosing is temporarily blocked because the pH value is too low for reliable chlorine control.
dos. time	Dosing is blocked because the specified maximum dosing time has been exceeded. After eliminating the cause of the error, this error message must be acknowledged by pressing the start button on the info page.
meas. err	Dosing is blocked because the sensor is not delivering a valid measured value.
pH problem	The chlorine dosing is blocked because the pH sensor is not delivering a valid measured value.
transmitt.	Dosing is blocked because the measured value transmitter is not working.
error	Dosing is blocked because the control electronics are not working.

Initial setup

Select language



Set date and time

By pressing the keys **+** resp. **-**. The current time and date can be set. The settings have to be saved by pressing the **OK** key.

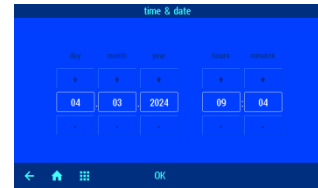

Adjust the flow rate of the measurement water

1. With the filter pump running, read the current flow rate on the display.
2. Using the measuring water flow control valve, adjust the flow rate to 0,5 l/min. At flow rates below 0.3 l/min or above 1.0 l/min an exact measurement of the chlorine concentration is not possible, and the automatic chlorine dosation is inhibited.



Calibrate the sensors

Turn on automatic dosing



In order to achieve good water quality, it is useful to operate the metering system a few days without automatic dosage before the calibration is performed. Otherwise, the calibration must be repeated after a few days.

Förderleistung der Dosierpumpen einstellen

The speed control of the metering pumps allows adjustment of the flow to the pool size. For the calculation of the flow following rule of thumb can be used:

$$\frac{\text{Pool volume in m}^3}{100} = \text{delivery rate in l/h}$$

The result of this calculation, however, is a guide only. The system characteristic values of the swimming pool, for example filter pump output, pipe lengths, temperature, usage behavior, etc. are not included in the formula.

Operation



Child lock

This symbol shows the status of the child lock.



On delivery, the child lock is switched off.

Activate the child lock:

Briefly touch this area on the screen with a finger



Deactivate the child lock:

Press the key symbol 5 seconds with a finger



When the child lock is active, all keys are locked!

Professional mode (expert level)

The WATERFRIEND provides protection against unwanted adjustment of important operating parameters. On delivery this protection function is activated. All functions shown in gray on the display are then locked.

Professional mode OFF (normal access)

Professional mode ON (extended access)



To turn off protection function, the key line is touched with a finger and swept from right to left.

(Note icon at top left of the symbol line)



One hour after the last touch of a button, the protection function is automatically turned on again.

To activate the protection function manually, the key line is again touched with a finger and swept from right to left. (Note the icon at top left of the symbol line).

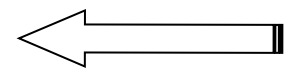

pH regulation

In this menu you can adjust various settings of the pH control.

Switching pH regulation on or off

Procedure:

1. Select **pH settings**
2. Select **Operating mode**
3. Select **Operation mode OFF** or **Operation mode Auto**

Press the  key



The selected setting is stored automatically.

Factory setting: Operation mode AUTO

Setting the pH target value

There is a setting facility for the required pH value in the menu.

Procedure:



1. Select **pH settings**
2. Select **Setpoint**

Press the  key



The current setpoint is shown on the left side of the display.

To adjust this value, the following two options are available:

- a) PLUS / MINUS keys
 - By pressing the arrow keys  or , the value can be modified stepwise.
 - Press  to store the new setting.

- b) Keyboard

The setpoint can also be set directly by using the keyboard on the right side of the display:

- enter the desired value (omitting the comma)
- Press  to store the new setting.

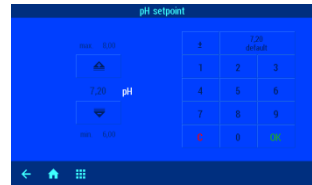

Factory setting: 7,2 Range: Between lower alarm limit and upper alarm limit

Setting the lower pH alarm

Im Menü befindet sich eine Einstellmöglichkeit für den gewünschten Alarm-Grenzwert.

Procedure:



1. Select **pH settings**
2. Select **lower alarm**

Press the  key



The currently selected value is shown on the left side of the display.

To adjust this value, the following two options are available:

- a) PLUS / MINUS keys
 - By pressing the arrow keys  or , the value can be modified stepwise.
 - Press  to store the new setting.

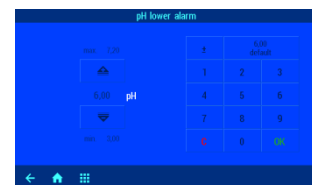

b) Keyboard

The value can also be set directly by using the keyboard on the right side of the display:

- enter the desired value (omitting the comma)
- Press  to store the new setting.

Factory setting: 6,0

Range: from 3,0 to regulation target value (setpoint)

Setting the upper pH alarm

There is a setting facility for the required alarm limit value in the menu.

Procedure:

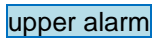
1. Select 
2. Select 



Press the  key



The currently selected value is shown on the left side of the display.

To adjust this value, the following two options are available:

a) PLUS / MINUS keys

- By pressing the arrow keys  or , the value can be modified stepwise.
- Press  to store the new setting.

b) Keyboard

The value can also be set directly by using the keyboard on the right side of the display:

- enter the desired value (omitting the comma)
- Press  to store the new setting.

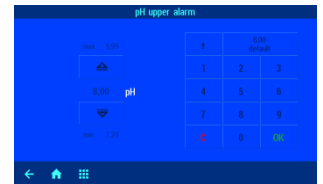

Factory setting: 8,0

Range: from regulation target value to 9,99

Calibrating the pH electrode



Calibration may only be performed by suitably qualified maintenance personnel. Proper control of the dosing quantities is only possible with correctly calibrated sensors. With incorrectly calibrated sensors, correct dosing of the chemicals cannot be guaranteed and dangerous overdosing can occur!

Once the sensors have been connected, every input must be calibrated during initial start-up. Calibration is also necessary if an electrode is replaced by a new one. The WATERFRIEND checks the calibration procedures for plausibility during the process (slope and offset). Non-calibrated and "badly" calibrated measurement inputs are displayed in plain text.

Time delays occur due to the electrode start-up times when the device is switched on.

The use-by date must be observed for the buffer solutions. The solutions must always be stored in a cool, dark place. Buffer solutions may not be soiled during use. For this reason, electrodes may not be immersed in different buffer solutions successively without cleaning them with distilled water first. It is also important not to rub the electrodes with a cloth, because this causes static charging and incorrect measurements. The necessary nsi buffer solutions for pH 4, pH 7 and for ORP 468mV and nsi spare electrodes are available from the nsi "WATERFRIEND" metering unit supplier.

The electrodes must be free of impurities, oils and fats etc before they are inserted in the flow fittings. Furthermore, the diaphragms (small spots at the probe point) must be free of coatings, soiling and crystallisation deposits. Do not touch the glass body with your hands to avoid impurities.

The pH electrode can generally be calibrated by a 1-point calibration. This can be done using the pH 7 buffer solution, or, on the fly; be done with the help of a photometer.

If the measured values deviate significantly, a 2-point calibration with 2 buffer solutions can also be carried out.

During the calibration, the measured electrode value and the pH values for the buffer solutions set are shown in the display. You can use these displayed values to ascertain the quality of the electrode during the calibration.

Calibrating the current working point or upper value (pH 7)

Procedure:

1. Select **pH settings**
2. Select **Calibration**

Press the  key



If the calibration is to be carried out using a photometer during operation as a one-point calibration, the actual pH value of the pool water should now be determined using a photometer. If the calibration is to be carried out using buffer solutions, the pH electrode must be unscrewed from the measurement chamber and then immersed in the green "pH 7" buffer solution.

Press the „Next“ key

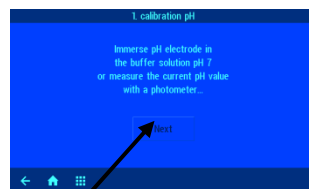

If a calibration is carried out at a pH value that deviates from pH 7, this value must first be entered after pressing the "Buffer solution" button.

The display shows the current values of the pH electrode (based on the last calibration). The new calibration value may only be saved when the value shown on the display no longer changes (this takes several minutes).

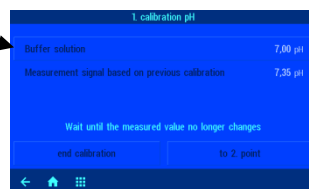

If a one-point calibration is to be carried out, this can be completed by pressing the "End calibration" button.

If a two-point calibration is desired, the second measuring point can be calibrated by pressing the "to 2. point" button.

Calibration of the lower value (pH 4)

For a two-point calibration, the lower point (pH 4) is calibrated in the next step. To do this, the pH electrode, previously cleaned with clean water, is immersed in the pH 4 buffer solution.

Warning: The electrode must not be rubbed with a cloth, as this will cause static charging, which will result in incorrect measurements.

Press the „Next“ button

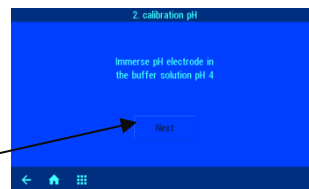

If a calibration is carried out with a buffer solution that deviates from pH 4, this value must first be entered after pressing the "Buffer solution" button.

The display shows the current values of the pH electrode (based on the last calibration). The new calibration value may only be saved when the value shown on the display no longer changes (this takes several minutes).

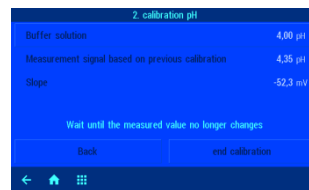

During the calibration, the slope of the electrode is shown on the display. The slope must be in a range between 45.0 to 65.0 mV. Otherwise the message "Big divergence" appears in the display.

Finally, press the "end calibration" button to save the setting.

pH calibration errors

If the calibration was not able to be completed and the Big divergence is shown in the display, the following causes are possible:

- The pH electrode is worn. The electrode service life is limited depending on the water quality and its care.
- You have mixed up the buffer solution sequence (1st pH 7, 2nd pH 4). This sequence must be strictly observed.

- You used the same buffer solution twice. Correct calibration can only be carried out with two different buffer solutions.
- The buffer solutions are used up or contaminated. In this case, use new buffer solutions.
- The electrode was connected to the wrong transmitter. The pH electrode must be connected to the black transmitter.
- The electrical connection between electrode and transmitter, or that between transmitter and controller, is contaminated or damaged.

pH power on delay





This setting should only be adjusted by a professional, and is only accessible in Expert Mode.

The controller only starts up after a delay period once the power supply has been provided and once external enable has been switched on (e.g. filter control unit). This power-on delay is necessary because a period specific to the overall system elapses once the filter pumps have been switched on before the completely mixed water reaches the sensors. This mixing process is mainly dependent on the pool size, the dimensions of the filter pump, the pipe length and the filter itself.

The delay period can, if required, be adapted to the actual pool size.

Procedure:



1. Select **pH settings**
2. Press the key  in the key bar
3. Select **Start delay**

Press the  key



The currently selected value is shown on the left side of the display.

To adjust this value, the following two options are available:

- a) PLUS / MINUS keys
 - By pressing the arrow keys  or , the value can be modified stepwise.
 - Press  to store the new setting.

- b) Keyboard

The value can also be set directly by using the keyboard on the right side of the display:

 - enter the desired value
 - Press  to store the new setting.

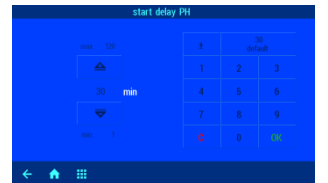

Factory setting: 30 minutes Range: 1 to 120 minutes

Setting the maximum pH metering time



This setting should only be adjusted by a professional, and is only accessible in Expert Mode.

The metering time limit is a safety function and prevents dangerous overdosing in cases of breakdown. Attention! The higher the maximum dosing time is set, the more acid can be released in an uncontrolled manner in case of any damage of the dosing tube.

The metering time must be adapted to the actual pool size.

Procedure:

1. Select **pH settings**
2. Press the key  in the key bar
3. Select **Maximum dosage** time



Press the  key



The currently selected value is shown on the left side of the display.

To adjust this value, the following two options are available:

a) PLUS / MINUS keys

- By pressing the arrow keys  or , the value can be modified stepwise.
- Press  to store the new setting.

b) Keyboard

The value can also be set directly by using the keyboard on the right side of the display:

- enter the desired value
- Press  to store the new setting.



Factory setting: 60 minutes Range: 1 to 300 minutes

Setting the pH proportional range





This setting should only be adjusted by a professional, and is only accessible in Expert Mode.

The controller offers the facility for setting the regulation proportional range in order to adapt the WATERFRIEND to the requirements of the specific swimming pool. This value influences the delivery quantity by optimizing the pulse-width modulation. This means that the duty cycle is modulated at constant frequency. The numeric value specifies the regulating conductance. At a deviation of the measured actual value from the desired value, which is greater than the P range, the metering pump operates with maximum power. If the actual value approaches the target value inside the proportional range, the metering performance decreases proportionally. This means that the pump is working at reduced power.

Increasing the p-range leads to a slower approach to the target value with less overshoot.

Procedure:

1. Select 
2. Press the key  in the key bar
3. Select 



Press the  key



The currently selected value is shown on the left side of the display.

To adjust this value, the following two options are available:

a) PLUS / MINUS keys

- By pressing the arrow keys  or , the value can be modified stepwise.
- Press  to store the new setting.

c) Keyboard

The value can also be set directly by using the keyboard on the right side of the display:

- enter the desired value (omitting the comma)
- Press  to store the new setting.



Factory setting: 1,00 Range: 0,1 to 2,0

Meaning of the proportional range

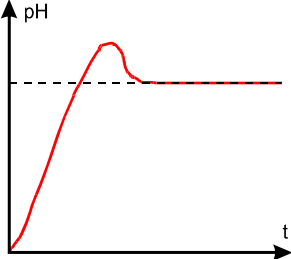
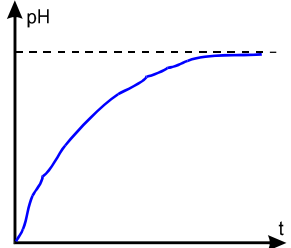
Adjustment	Benefits	Disadvantages	Diagram
Small P-range	Fast, accurate control	When switching on an overshoot can occur	
Wide P-range	No overshoot	Slow control, small deviations between desired and actual values possible	

Control behavior at P=0.5

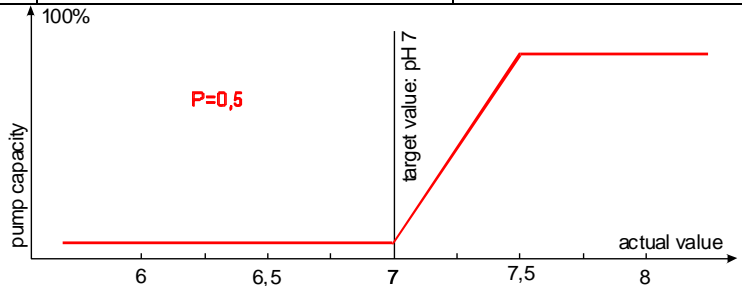

Control behavior at P=1

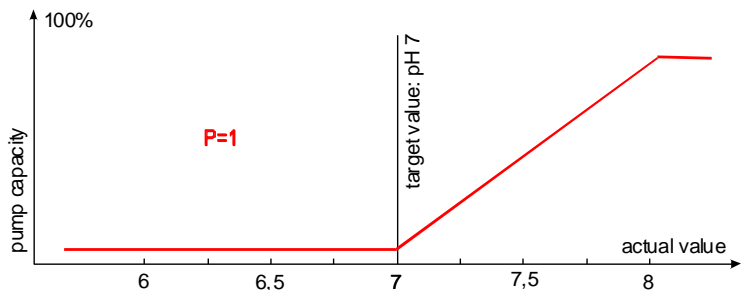

pH metering pump flow rate

The integrated speed control for the metering pumps enables optimum adaptation of the regulation to the pool size.

Procedure:

1. Select **pH settings**
2. Press the key  in the key bar
3. Select **Capacity dosing pump**



Press the  key



The currently selected value is shown on the left side of the display.

To adjust this value, the following two options are available:

a) PLUS / MINUS keys

- By pressing the arrow keys  or , the value can be modified stepwise.
- Press  to store the new setting.

b) Keyboard

The value can also be set directly by using the keyboard on the right side of the display:

- enter the desired value (omitting the comma)
- Press  to store the new setting.



Factory setting: 1,5 l/h Range: 0,2 to 10,0 l/h

Chlorine regulation

In this menu you can adjust various settings of the chlorine control.

Switching chlorine regulation off or on

Procedure:

1. Select **Chlorine settings**
2. Select **Operating mode**
3. Select **Operation mode OFF** or **Operation mode Auto**

Press the  key



The selected setting is stored automatically.

Factory setting: Operation mode AUTO

Setting the chlorine target value

There is a setting facility for the desired chlorine value in the menu.

Procedure:

1. Select **Chlorine settings**
2. Select **Setpoint**



Press the  key



The currently selected value is shown on the left side of the display.

To adjust this value, the following two options are available:

a) PLUS / MINUS keys

- By pressing the arrow keys  or , the value can be modified stepwise.
- Press  to store the new setting.

b) Keyboard

The value can also be set directly by using the keyboard on the right side of the display:

- enter the desired value (omitting the comma)
- Press  to store the new setting.



Factory setting: 0,45 Range: between the lower and the upper alarm limit

Setting the lower chlorine alarm



There is a setting facility for the required alarm limit value in the menu.

Procedure:

1. Select **Chlorine settings**
2. Select lower alarm

The currently selected value is shown on the left side of the display.

To adjust this value, the following two options are available:

- a) PLUS / MINUS keys
 - By pressing the arrow keys  or , the value can be modified stepwise.
 - Press  to store the new setting.
- b) Keyboard

The value can also be set directly by using the keyboard on the right side of the display:

- enter the desired value (omitting the comma)
- Press  to store the new setting.

Press the  key

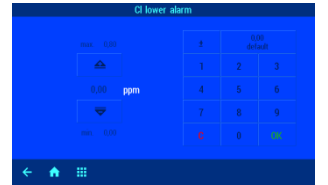

Factory setting: 0,1 Range: from 0,01 to chlorine target value (setpoint)

Setting the upper chlorine alarm



There is a setting facility for the required alarm limit value in the menu.

Procedure:

1. Select **Chlorine settings**
2. Select **upper alarm**

The currently selected value is shown on the left side of the display.

To adjust this value, the following two options are available:

- a) PLUS / MINUS keys
 - By pressing the arrow keys  or , the value can be modified stepwise.
 - Press  to store the new setting.
- b) Keyboard

The value can also be set directly by using the keyboard on the right side of the display:

- enter the desired value (omitting the comma)
- Press  to store the new setting.

Press the  key

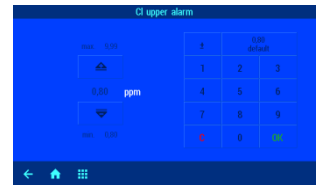

Factory setting: 0,8 Range: from chlorine target value to 9,99

Calibrating the chlorine sensor



Calibration may only be performed by suitably qualified maintenance personnel. Proper control of the dosing quantities is only possible with correctly calibrated sensors. With incorrectly calibrated sensors, correct dosing of the chemicals cannot be guaranteed and dangerous overdosing can occur!

Once the sensors have been connected, every input must be calibrated during initial start-up. Calibration is also necessary if an electrode is replaced by a new one. The WATERFRIEND checks the calibration procedures for plausibility during the process (slope and offset). Non-calibrated and "badly" calibrated measurement inputs are displayed in plain text.

Time delays occur due to the electrode start-up times when the device is switched on.

The calibration is carried out as a one-point calibration with a reference measurement. The reference measurement is done using a photometer. This photo meter is a portable instrument and is not supplied with the metering system "MRD WATERFRIEND-3".

For a successful calibration, the pH value must be in the normal range. Otherwise, the calibration of the chlorine sensor is not possible.

Preparations:

1. Adjust the measurement water flow rate to 0,5 l/min using the measuring water control valve
2. Take a sample of the pool water from the drain valve in the measurement chamber
3. Determine the chlorine content of the water sample with the photometer

Procedure:

1. Select **Chlorine settings**
2. Select **Calibration**

Press the  key



Press the "Next" button

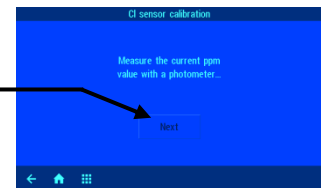

Press the **Photometer value** button and enter the measured chlorine value.

The current values of the chlorine electrode (based on the last calibration) are shown in the display. Only when the value shown on the display no longer changes, the new calibration value may be saved using the **end calibration** button.

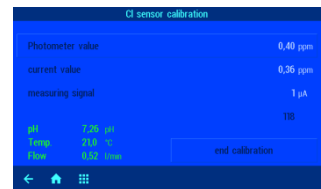

The calibration is now complete and the standard display appears again in the display.

Chlorine calibration errors

If the calibration cannot be completed and the key **end calibration** is grayed out, the pH or the sample water flow rate probably is not in the regular region. The values are then displayed in red.

Power-on delay of chlorine regulation





This setting should only be adjusted by a professional, and is only accessible in Expert Mode.

The controller only starts up after a delay period once the power supply has been provided and once external enable has been switched on (e.g. filter control unit). This power-on delay is necessary because a period specific to the overall system elapses once the filter pumps have been switched on before the completely mixed water reaches the sensors. This mixing process is mainly dependent on the pool size, the dimensions of the filter pump, the pipe length and the filter itself.

The delay period can, if required, be adapted to the actual pool size.

Procedure:



1. Select **Chlorine settings**
2. Press the key  in the key bar
3. Select **Start delay**

Press the  key



The currently selected value is shown on the left side of the display.

To adjust this value, the following two options are available:

- a) PLUS / MINUS keys
 - By pressing the arrow keys  or , the value can be modified stepwise.
 - Press  to store the new setting.

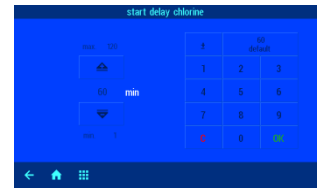

- b) Keyboard

The value can also be set directly by using the keyboard on the right side of the display:

 - enter the desired value
 - Press  to store the new setting.

Factory setting: 60 minutes Range: 1 to 120 minutes

Setting the maximum chlorine metering time





This setting should only be adjusted by a professional, and is only accessible in Expert Mode.

The dosing time is a safety feature and prevents dangerous overdosing in case of failure. Attention! The larger the maximum dosing time is set, the more chlorine solution can be released in an uncontrolled manner in case of any damage to the dosing tube!

The metering time must be adapted to the actual pool size.

Procedure:



1. Select **Chlorine settings**
2. Press the key  in the key bar
3. Select **Maximum dosage time**

Press the  key



The currently selected value is shown on the left side of the display.

To adjust this value, the following two options are available:

- a) PLUS / MINUS keys
 - By pressing the arrow keys  or , the value can be modified stepwise.
 - Press  to store the new setting.

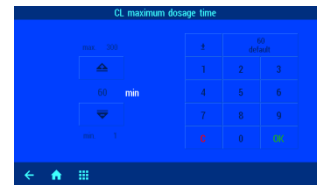

- b) Keyboard

The value can also be set directly by using the keyboard on the right side of the display:

 - enter the desired value
 - Press  to store the new setting.

Factory setting: 60 minutes Range: 1 to 300 minutes

Setting the chlorine proportional range





This setting should only be adjusted by a professional, and is only accessible in Expert Mode.

The controller offers the facility for setting the regulation proportional range in order to adapt the WATERFRIEND to the requirements of the specific swimming pool. This value influences the delivery quantity by optimizing the pulse-width modulation. This means that the duty cycle is modulated at constant frequency. The numeric value specifies the regulating conductance. At a deviation of the measured actual value from the desired value, which is greater than the P range, the metering pump operates with maximum power. If the actual value approaches the target value inside the proportional range, the metering performance decreases proportionally. This means that the pump is working at reduced power.

Increasing the p-range leads to a slower approach to the target value with less overshoot.

Procedure:



1. Select Chlorine settings
2. Press the key  in the key bar
3. Select P-range

Press the  key



The currently selected value is shown on the left side of the display.

To adjust this value, the following two options are available:

- a) PLUS / MINUS keys
 - By pressing the arrow keys  or , the value can be modified stepwise.
 - Press  to store the new setting.
- b) Keyboard

The value can also be set directly by using the keyboard on the right side of the display:

 - enter the desired value (omitting the comma)
 - Press  to store the new setting.



Factory setting: 0,5 Range: 0,05 to 1,0

Impact of the proportional range

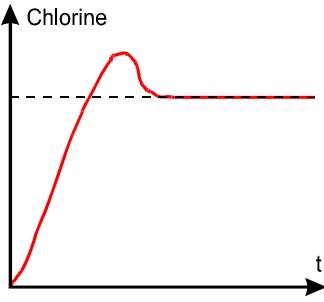
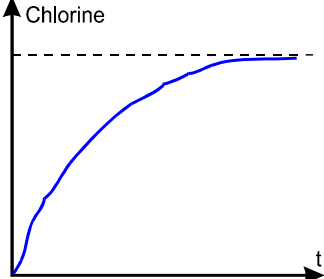
Adjustment	Benefits	Disadvantages	Diagram
Narrow P-range	Fast, accurate control	When switching on, an overshoot can occur	
Wide P-Range	No overshoot	Slow control, small deviations between desired and actual values possible	

Control behavior at P=0.5

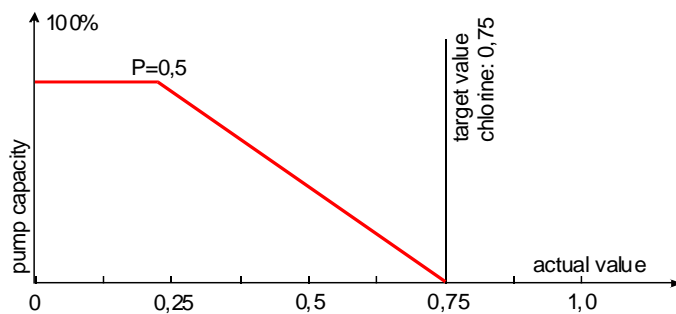

Control behavior at P=0.25

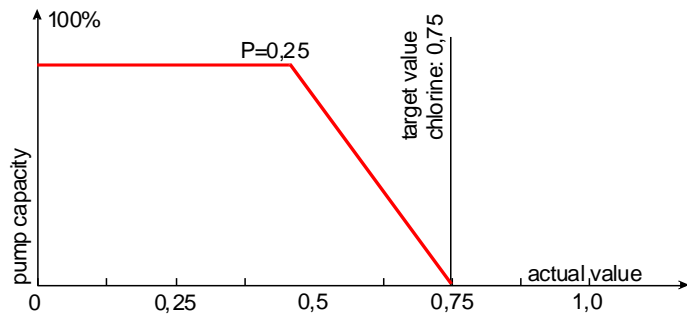

Chlorine metering pump flow rate

The integrated speed control for the metering pumps enables optimum adaptation of the regulation to the pool size.

Procedure:



1. Select **Chlorine settings**
2. Press the key  in the key bar
3. Select **Capacity chlorine pump**

Press the  key



The currently selected value is shown on the left side of the display.

To adjust this value, the following two options are available:

- a) PLUS / MINUS keys
 - By pressing the arrow keys  or , the value can be modified stepwise.
 - Press  to store the new setting.

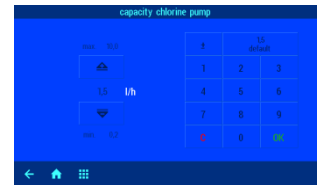

- b) Keyboard

The value can also be set directly by using the keyboard on the right side of the display:

 - enter the desired value (omitting the comma)
 - Press  to store the new setting.

Factory setting: 1,5 l/h Range: 0,2 to 10,0 l/h

ORP display

In this menu you can adjust various settings of the ORP supervision.

Setting the lower ORP alarm

There is a setting facility for the required alarm limit value in the menu.

Procedure:



1. Select **ORP settings**
2. Select **lower alarm**

Press the  key



The currently selected value is shown on the left side of the display.

To adjust this value, the following two options are available:

- a) PLUS / MINUS keys
 - By pressing the arrow keys  or , the value can be modified stepwise.
 - Press  to store the new setting.

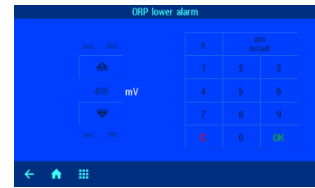

- b) Keyboard

The value can also be set directly by using the keyboard on the right side of the display:

 - enter the desired value
 - Press  to store the new setting.

Factory setting: 400 mV Range: 300 to 700 mV

Setting the upper ORP alarm

There is a setting facility for the required alarm limit value in the menu.

Procedure:



1. Select **ORP settings**
2. Select **upper alarm**

Press the  key



The currently selected value is shown on the left side of the display.

To adjust this value, the following two options are available:

- a) PLUS / MINUS keys
 - By pressing the arrow keys  or , the value can be modified stepwise.
 - Press  to store the new setting.

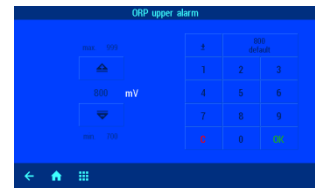

- b) Keyboard

The value can also be set directly by using the keyboard on the right side of the display:

 - enter the desired value
 - Press  to store the new setting.

Factory setting: 800 mV Range: 700 to 999 mV

Setting the ORP power on delay



This setting should only be adjusted by a professional, and is only accessible in Expert Mode.

The controller only starts up after a delay period once the power supply has been provided and once external enable has been switched on (e.g. filter control unit). This power-on delay is necessary because a period specific to the overall system elapses once the filter pumps have been switched on before the completely mixed water reaches the sensors. This mixing process is mainly dependent on the pool size, the dimensions of the filter pump, the pipe length and the filter itself.

The delay period can, if required, be adapted to the actual pool size.

Procedure:



1. Select **ORP settings**
2. Select **Start delay**

Press the  key



The currently selected value is shown on the left side of the display.

To adjust this value, the following two options are available:

- a) PLUS / MINUS keys
 - By pressing the arrow keys  or , the value can be modified stepwise.
 - Press  to store the new setting.

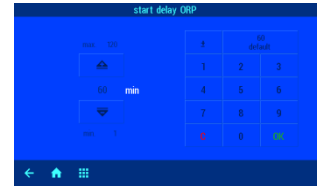

- b) Keyboard

The value can also be set directly by using the keyboard on the right side of the display:

 - enter the desired value
 - Press  to store the new setting.

Factory setting: 60 minutes Range: 1 to 120 minutes

Calibrating the ORP electrode



Calibration may only be performed by suitably qualified maintenance personnel. Proper control of the dosing quantities is only possible with correctly calibrated sensors. With incorrectly calibrated sensors, correct dosing of the chemicals cannot be guaranteed and dangerous overdosing can occur!

Once the sensors have been connected, every input must be calibrated during initial start-up. Calibration is also necessary if an electrode is replaced by a new one. The WATERFRIEND checks the calibration procedures for plausibility during the process (slope and offset). Non-calibrated and "badly" calibrated measurement inputs are displayed in plain text.

Time delays occur due to the electrode start-up times when the device is switched on.

The use-by date must be observed for the buffer solutions. The solutions must always be stored in a cool, dark place. Buffer solutions may not be soiled during use. For this reason, electrodes may not be immersed in different buffer solutions successively without cleaning them with distilled water first. It is also important not to rub the electrodes with a cloth, because this causes static charging and incorrect measurements. The necessary nsi buffer solutions for pH 4, pH 7 and for ORP 468mV and nsi spare electrodes are available from the nsi "WATERFRIEND" metering unit supplier.

The electrodes must be free of impurities, oils and fats etc before they are inserted in the flow fittings. Furthermore, the diaphragms (small spots at the probe point) must be free of coatings, soiling and crystallisation deposits. Do not touch the glass body with your hands to avoid impurities.

The ORP value is measured with the help of the ORP electrode. This is a direct measure of the germ killing rate, i.e. the effectiveness of the disinfectant.

The calibration is carried out as a 1-point calibration with a 468mV buffer solution. This buffer solution must be free of impurities and fresh.

During the calibration, the measured electrode voltage value and the ORP value of the buffer solution are shown in the display. You can use these displayed values to ascertain the quality of the electrode during the calibration.

Procedure:

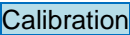
1. Select 
2. Select 

Press the  key



The ORP electrode is immersed in the 468mV buffer solution. The current value for the ORP electrode is then shown in the display. **The discrepancy between the displayed value and the buffer solution value (468mV) should not exceed $\pm 10\%$. If there is a large discrepancy or extended reaction time, the electrode should be replaced as soon as possible.**

When the value in the display does not change any more, the new offset has to be stored by pressing the key .

The calibration is now complete, the display returns to the default display.

ORP calibration errors

If the calibration was not able to be completed or the discrepancy is larger than 10%, the following causes are possible:

- The ORP electrode is worn. The electrode service life is limited depending on the water quality and its care.
- You used the wrong buffer solution. It is imperative that 468mV is used. Calibration is not possible if other buffer solutions are used.
- The buffer solution is used up or contaminated. In this case, use a new buffer solution.
- The electrode was connected to the wrong transmitter. The ORP electrode must be connected to the white transmitter.
- The electrical connection between electrode and transmitter, or that between transmitter and controller, is contaminated or damaged.

Info and alarm display

The WATERFRIEND offers the possibility of status information and error messages on one page view.

Procedure:

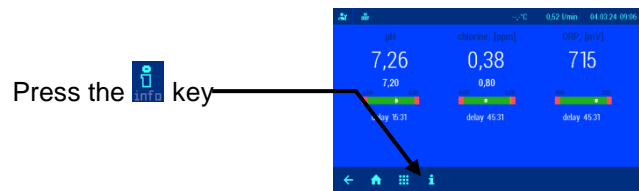

Display:

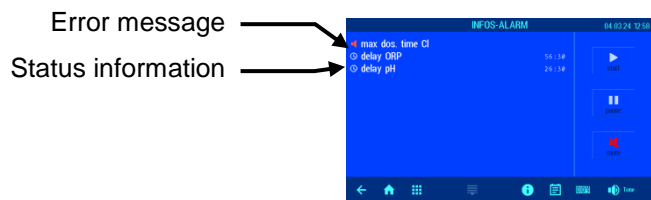

Acknowledgement of alarm messages

The acoustic fault signal can be switched off by pressing the  button.

If the controller has stopped operation due to an error, it can be restarted after resolving the error by pressing the  button.

Automatic operation can be temporarily interrupted with the  key.

Graphic of the measured values

The WATERFRIEND offers the option of displaying the saved measured values graphically.

Procedure:

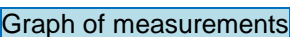
Select 



By pressing the  button, the time range of the displayed values can be changed.

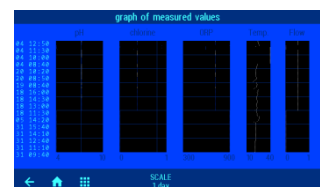

Operation log

The WATERFRIEND offers the option of showing the saved protocol on the display.





Procedure:

Press the  key

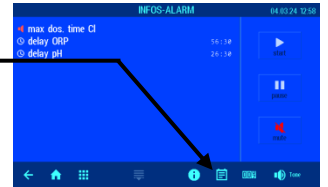

Press the key  in the key bar



The month to be displayed can be selected using the  and  keys; the  and  keys are used to turn the log pages.

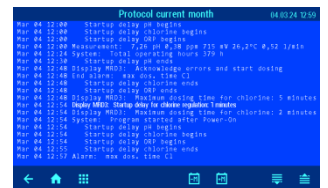

Manual operation

The WATERFRIEND provides the ability to manually turn on the metering pumps to vent the dosing tubes or perform a shock chlorination.

Procedure:

Press the  key



Select **Hand dosage**

Venting the dosing tubes

Shock chlorination

By pressing the appropriate button each dosing pump can be switched on and off. The respective status indicator is to be observed. The maximum duration is limited to 60 seconds. After this time, the pump will automatically turn off. The remaining time is shown on the display (in seconds).



The third pump (option) can only be controlled in manual mode when it is configured for pH +.

Flocculation (Option)

The WATERFRIEND offers the optional ability to perform automatic flocculant dosage with a third metering pump.

Setting the capacity of the flocculation pump

Procedure:



Press the  key

1. Select **Flocculation settings**
2. Select **capacity flocculation pump**



The currently selected value is shown on the left side of the display.

To adjust this value, the following two options are available:

- a) PLUS / MINUS keys
 - By pressing the arrow keys  or , the value can be modified stepwise.
 - Press  to store the new setting.
- b) Keyboard

The value can also be set directly by using the keyboard on the right side of the display:

 - enter the desired value
 - Press  to store the new setting.



Factory setting: 5 ml/h Range: 2 to 250 ml/h

Switching the flocculation off or on

Procedure:

1. Select **Flocculation settings**
2. Select **Flocculation OFF** or **Flocculation ON**

The selected setting is stored automatically.

Press the  key

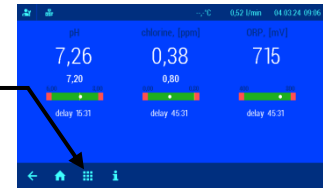

Factory setting: OFF

Venting the flocculation tube

This function makes it possible to vent the flocculant tube with an increased output of 1l / h.

Procedure:

1. Select **Flocculation settings**
2. Select **Fill hose 1l/h START** or **STOP**

Press the  key

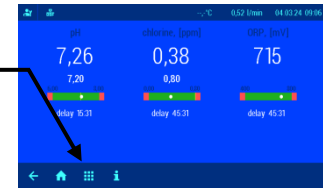

The maximum duration is limited to 60 seconds. After this time, the pump will automatically turn off. The remaining time is shown on the display (in seconds).

Settings for the service technician

In the menu Service Functions the dosing control can be configured for the particular application.

Settings for the real time clock

For the built-in real time clock different operating modes can be set.

Automatic Internet time

If the WATERFRIEND has an active Internet connection, the built-in clock can be automatically synchronized with the Internet.

Procedure:

1. Select **Service functions**
2. Wählen Sie **Uhrzeit und Datum**
3. Select automatic internet time **ON** or **OFF**

Press the  key



Factory setting: automatic internet time ON

Time zone

If the WATERFRIEND the built-in clock automatically synchronized with the Internet, the local time zone must be selected with this function.

Procedure:

1. Select **Service functions**
2. Select **time & date**
3. Select **time zone**
4. Select the appropriate local time zone.

Press the  key



Factory setting: GMT+1h, Central europe

Manual time setting

If the built-in clock is not automatically synchronized with the Internet, it must be set manually with this function.

Procedure:

1. Select **Service functions**
2. Select **time & date**
3. Select Manual time setting
4. Use the keys **+** and **-** to set time and date, and then confirm with **OK**.

Press the  key



Automatic daylight saving time

The WATERFRIEND can automatically switch to daylight saving time.

Procedure:

1. Select **Service functions**
2. Select **time & date**
3. Select daylight saving time automatic **ON** oder **OFF**

Press the  key



Factory setting: Automatic daylight saving time ON

Audible alarm

The output of acoustic alarms can be enabled or disabled with this function.

Procedure:

1. Select **Service functions**
2. Select **Alarm set**
3. Press the speaker icon to turn the audible alarms on or off.

Press the  key

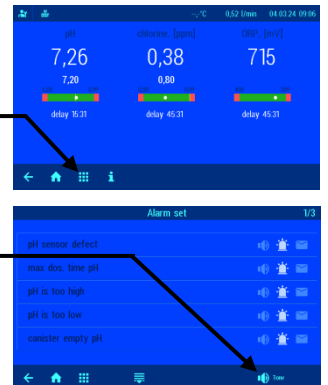



Factory setting: Audible Alarm ON

Alarm settings

This function can be used to individually determine which type of alarm messages should be generated for each individual alarm condition.

Procedure:

1. Select **Service functions**
2. Select **Alarm set**
3. Select the desired alarms

For each individual alarm type, you can choose whether an acoustic alarm is generated () , an e-mail is sent () , or the collective fault message is activated () .

Press the  key



Restore factory settings

With this function, all user programmable parameters are reset to the factory settings.



This function should only be used by a professional, and is only accessible in Expert Mode.

Procedure:

1. Select **Service functions**
2. Select **Factory settings**
3. Answer **YES** or **NO** to the confirmation query.

Press the  key



Settings for network operation

For operation in the network (LAN or Internet), various parameters need to be set.

Using the ISI-communication server

For a simplified access to the device from the Internet the ISI-communication server can be used.

Procedure:

1. Select **Service functions**
2. Select **network settings**
3. Activate or deactivate the function **Internet connection via communication server**.

Press the  key



Factory setting: Internet connection via communication server active

Automatic IP address configuration (DHCP)

For a simplified connection of the device to the local network automatic IP configuration via DHCP can be used.

Procedure:

1. Select **Service functions**
2. Select **network settings**
3. Activate or deactivate the function **IP address automatic**.

Press the  key



Factory setting: DHCP active

Manual IP address configuration

If the IP addresses are not configured automatically via DHCP, they can be set manually with this function.

Procedure:

1. Select **Service functions**
2. Select **network settings**
3. Set the IP addresses required for the local network manually using the function **IP address manually**.

Press the  key



PIN-Numbers

With this function, the PIN numbers for the operation of the device via the network interface can be set.

Procedure:

1. Select **Service functions**
2. Select **network settings**
3. Use the **LAN-PIN** function to set the desired PIN numbers (4 digits) for users and service technicians (Expert Mode). The Service PIN can only be changed in expert mode. If the PIN is set to 0000, the control can be operated over the LAN interface without a PIN authorization.

Press the  key



Factory setting: LAN-Pin=1234, Service-PIN=5678

Language selection

For the indications on the display several languages can be selected.

Procedure:

1. Select **Service functions**
2. Press the flag icon on the bottom line
3. Select the desired language.

Press the  key

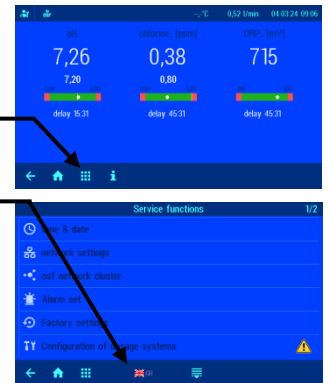

Operating hours counter

With this function, the total hours of operation of the device, and the operating hours of the individual sensors since the last calibration can be displayed.

Procedure:

Press the key  in the key bar

Press the  key

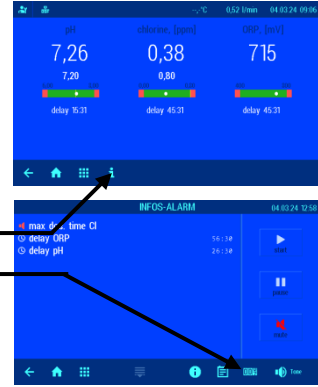

Device informations

With this function, information on the network connection and the installed application software can be retrieved.

Procedure:

Press the  key

Press the key  in the key bar



Configuration of the metering pumps

With this function, the function of the pH pump and the optional third pump can be configured.



This setting should only be changed by a professional, and is only accessible in Expert Mode.

Raise pH <=> lower pH

In order to adapt the WATERFRIEND to the requirements of the swimming pool, the control offers the possibility of switching the function of the pH pump between the modes raise pH or lower pH.

Procedure:

1. Select Service functions
2. Select Configuration of dosage systems
3. Select 1. Pump
4. Select pH down or pH up.
5. To save the configuration changes, press the Save button and answer the following security prompt with YES

Press the  key



Note: When changing between pH-lowering and pH-elevating chemicals the suction lance, the metering tube and the injection valve must be rinsed with water and thoroughly cleaned.

Factory setting: pH down

Function of the third metering pump (option)

The optional third dosing pump can either be used as flocculation pump or for raising the pH for a bidirectional control of pH.

Procedure:

1. Select **Service functions**
2. Select **Configuration of dosage systems**
3. Select **3. Pump**
4. Select **3rd pump disabled** or **3rd pump for flocculation** or **3rd pump for pH+**.
5. To save the configuration changes, press the **Save** button and answer the following security prompt with **YES**

Press the  key



Factory setting: 3rd pump disabled

Bidirectional control for pH (pH+ and pH-)

If the third pump is configured for the function raise pH to implement a bidirectional control of the pH value, the setting menu for the parameters of the pH control is extended:



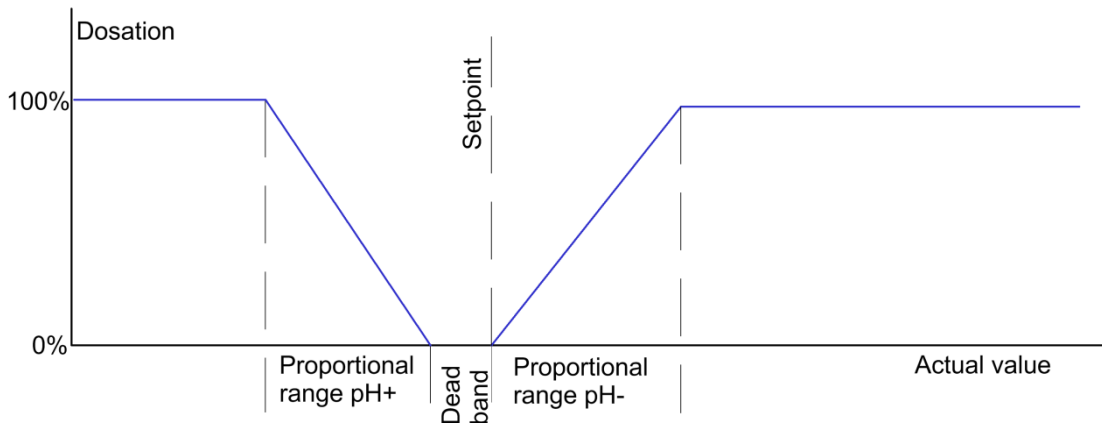

- The values for the proportional range and the pump output can be set separately for both pumps.
- You can specify a dead band for the pH+ pump, in which neither of the two metering pumps is active



Calibration of the temperature sensor

With this feature, the temperature sensor in the flow cell can be calibrated.

Procedure:

1. Select **Service functions**
2. Press the key  in the key bar
3. Select **Temperature korrektion.**
4. By pressing the arrow keys  or , or with the keyboard on the right of the display, the actual temperature value measured with a thermometer is entered.
For confirmation, press the  button!

Press the  key



Alternative operation with ORP control

This function can be used to switch from controlling the chlorine content to controlling the ORP value if a perfect chlorine measurement is not possible. This case can occur, for example, if the water contains cyanuric acid (“organic chlorine”) and therefore chlorine measurement using a photometer is not possible for calibration.

Procedure:

1. Select **Service functions**
2. Select **Configuration of dosage systems**
3. Press the construction site symbol
4. Select **control of disinfection by chlorine (main program)** or **control of disinfection by ORP (emergency program)**.

Press the  key

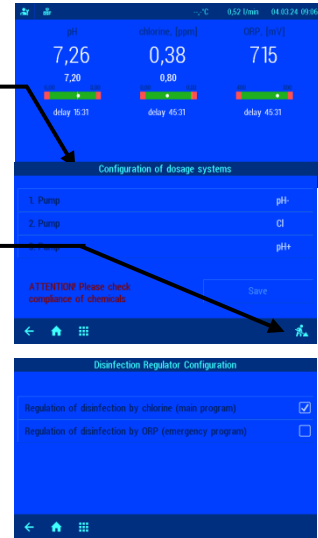

Connecting the MRD-3 to the external touch control panel (smart)

As an alternative to the osf bus (RS-485), communication can also take place via a local Ethernet network using the UDP network protocol. For correct cooperation, both controllers must be connected to the same local network. Patch cables are used for the connection. One end of the patch cable is connected to the LAN port of the controller and the other end to the network switch of the local network.

On the external touch controller (smart) screen, open the menu for adding an osf device and select the “MRD-2” controller. Then follow the suggested instructions, click the Start button and then click the LAN button in the MRD-2 osf network cluster menu. For more information, see the instructions for the external touch control panel (smart).

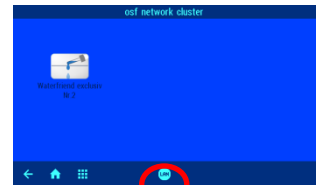

Please also note the assembly and operating instructions for the external touch control panel (smart).

Maintenance

Service work may only be carried out on de-pressurised, voltage-free equipment which has been protected against unauthorised switching on.

The metering unit should be serviced by specialist personnel at regular intervals.

6-monthly service

Sealtightness

Check all connections for sealtightness at regular intervals.

Dirt filter

The filter screen should be checked for soiling and accumulations at regular intervals. The filter screen must be cleaned or replaced if necessary.

Injection valves

The injection valves should be checked for soiling and accumulations at regular intervals. They should be cleaned if necessary.

pH electrode

The electrode function is checked at regular intervals using the two buffer solutions (pH7 and pH4). If there are any noticeable variations, the electrode should be calibrated or replaced (see above in manual, "Calibrating pH electrode").

ORP electrode

The electrode function is checked at regular intervals using buffer solution 468mV. If there are any noticeable variations, the electrode should be calibrated or replaced (see above in manual, "Calibrating ORP electrode").

Metering pumps



Protect yourself against the metering media, wear appropriate protective clothing.

Once the pump has cooled down, check the hose for any possible damage. The pump hose must be circular and may not show any signs of leakage or damage. Any damaged hoses must be replaced.

Annual service

Replacing ORP and pH electrodes

The electrodes should be replaced at intervals of one year (see above in manual, "Calibrating electrodes").

Replacing the metering hose



Protect yourself against the metering media, wear appropriate protective clothing.

The metering hoses should be replaced at intervals of one year.

Decommissioning

If the metering unit will not be used for long periods, for example during the winter, the following measures are necessary.

Electrodes

Remove the electrodes from the measuring chamber and place them in the container filled with storage fluid in which the electrode was delivered.

Measuring chamber

Empty the measuring chamber.

Metering pumps

Rinse out the metering hoses thoroughly with water. Empty the metering hoses and remove them from the metering pumps.

Wear parts

The following components are wear parts for which no guarantee can be provided:

- electrodes
- metering pump hoses
- buffer solutions

Interfacing with building automation systems

The MRD-3 contains an HTTP web server, which is designed to allow the control unit to be operated using any web browser from any web-enabled terminal.

The HTML pages generated by this web server can also be accessed by a building automation system and can be interpreted for display on EIB visualization devices. For the purpose of controlling the MRD-3, the building automation system can generate IP messages, in the same way as they would be generated by a web browser when you click on controls on the HTML pages. In other words, the building automation system must emulate a web browser.

Instead of using directly the predefined HTML pages designed by ISI for displaying on web browsers, you (as user) can also design your own control file to obtain the data you require in "custom" form, and save this file on the SD card in the MRD-3. This means that the interface to the building automation system is then unaffected by potential design changes to the ISI HTML pages.

This control file must be saved as an ASCII text file with the extension ".HTM" in the "HTML" folder on the SD card. The file name must not exceed 8 characters in length. Although it has the "HTM" extension, this file need not necessarily be a valid HTML file, but can be formatted to suit the requirements of the building automation system.

This control file can contain variables in the format "\$\$nnnn", which the web server then replaces with the data that is currently valid. A list of available variables appears at the end of this document.

A control file "ISTWERTE.HTM" containing the following:

```
pH value: $$0001 pH
ORP value: $$0003 mV
```

would, on opening "http://xxx.xxx.xxx.xxx/istwerte.htm", return the following text for example:

```
pH value: 7.26 pH
ORP value: 689 mV
```

These control files can also be used selectively to read specific datapoints, e.g. "CHLOR.HTM" containing the following:

```
$$0002
returns
0.38
```

In order to make changes to data in the control unit from the building automation system, the building automation system must emulate sending an HTML form. This is done by a URL invocation in the form "http://xxx.xxx.xxx.xxx/modify?nnnn=data", where nnnn is the number of the variable to be changed, and data represents the data to be stored.

Before the building automation system can change any variables, it must first log in by sending a valid PIN number to the variable 0003:

„http://xxx.xxx.xxx.xxx/modify?0000=dddd“, where dddd is the user PIN configured in the unit.

Variables can be set after successful login, e.g. set the chlorine value to 0.5 ppm:

„http://xxx.xxx.xxx.xxx/modify? 0012=0.5“.

Afterwards, the building automation system should log out by writing to the variable 0003 again with any invalid value:

„http://xxx.xxx.xxx.xxx/modify?0000=0000“

A similar call sequence can be used, for example, to switch the operating mode of the chlorine control:

„http://xxx.xxx.xxx.xxx/modify?0000=dddd“	Login
„http://xxx.xxx.xxx.xxx/modify?0032=i“	Switch operating mode
„http://xxx.xxx.xxx.xxx/modify?0000=0000“	Logout

Variables available for communication with the building management system:

Number	Description	Read/Write	Data format	Range	Info
0000	LAN-PIN	W	„####“	„0000“ - „9999“	Login
0001	Actual value pH	R	„#.##“		pH
0002	actual value chlorine	R	„#.##“		ppm
0003	Actual value ORP	R	„###“		mV
0004	Actual value temperature	R	„##.#“		°C
0005	Actual value water flow	R	„#.##“		l/min
0011	Setpoint pH	R/W	„#.##“	„6.00“ - „8.00“	pH
0012	Setpoint chlorine	R/W	„#.##“	„0.00“ - „0.80“	ppm
0021	Status message pH controller	R	Text		
0022	Status message chlorine controller	R	Text		
0023	Status message ORP supervision	R	Text		
0026	Current dosing rate pH	R	„##.##“		l/h
0027	Current dosing rate chlorine	R	„##.##“		l/h
0031	Operating mode pH controller	W	ASCII	'0', '1', 'i'	0: Auto mode on 1: Auto mode off i: Switch modes
0032	Operating mode chlorine controller	W	ASCII	'0', '1', 'i'	0: Auto mode on 1: Auto mode off i: Switch modes
0041	Lower alarm limit value pH	R/W	„#.##“	„3.00“ - „8.00“	pH
0042	Lower alarm limit value chlorine	R/W	„#.##“	„0.00“ - „0.80“	ppm
0043	Lower alarm limit value ORP	R/W	„###“	„300“ - „700“	mV
0051	Upper alarm limit value pH	R/W	„#.##“	„6.00“ - „9.99“	pH
0052	Upper alarm limit value chlorine	R/W	„#.##“	„0.00“ - „9.99“	ppm
0053	Upper alarm limit value ORP	R/W	„###“	„700“ - „999“	mV
0102	Operating mode flocculation	w	ASCII	'0', '1', 'i'	0: Auto mode on 1: Auto mode off i: Switch modes
9000	Collective fault message	R	'#'	'0' - '1'	'0'=Off, '1'=On
9031	Status variable pH control	R	'#'	'0' - '1'	'0'=Off, '1'=Automatic
9032	Status variable chlorine control	R	'#'	'0' - '1'	'0'=Off, '1'=Automatic
9102	Status variable Flocculation	R	'#'	'0' - '1'	'0'=Off, '1'=Automatic

We hope you have a lot of enjoyment and relaxation in your swimming pool

Further information can be found on the Internet at the following address:

<https://osf.de/download/documents/documents.php?device=MRD-3-7-Zoll>



OSF Hansjürgen Meier

Elektrotechnik und Elektronik GmbH & Co KG

Eichendorffstrasse 6

D-32339 Espelkamp

E-Mail: info@osf.de

Internet: www.osf.de

Änderungen vorbehalten!



Shipment of the dosing system



WATERFRIEND



Declaration of non-objection

If you have to return a **WATERFRIEND**, you must send this form, filled out, back with every return device.

Type:

Serial number:

Diese Seite abtrennen und für die Rücksendung verwenden!

We hereby guarantee that we have professionally cleaned the device before shipping. It is free of corrosive substances and other chemical substances which could cause a health hazard. This means that there are no hazards caused by residual contamination. This form has been correctly and completely filled out and the device has been shipped in accordance with the statutory requirements.

If the manufacturer has to carry out cleaning work, all costs incurred will be invoiced.

Please fill out legibly:

Company:

Road: Postcode, town

Country: Telephone:

E-mail: Fax:.....

Surname: First name:.....

Date:

Signature: Stamp:

osf Hansjürgen Meier · Elektrotechnik und Elektronik GmbH & Co KG

Hausanschrift

Eichendorffstraße 6 Telefon: +49(0) 5772/9704-0
D-32339 Espelkamp Telefax: +49(0) 5772/5730

E-Mail: info@osf.de
Internet: www.osf.de



